

Diplomat Electric

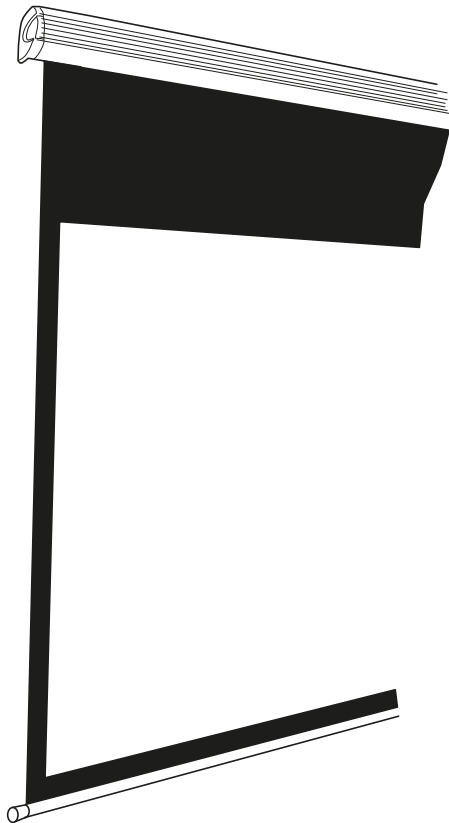

Thank you for choosing a Euroscreen® to be part of your AV installation. We hope it will bring you many hours of entertainment and/or education depending on your preference. Please read through the manual completely before installation and usage.

Tack för att ni valt en Euroscreen® som en del i er AV-installation. Vi hoppas den kan ge er många timmar av underhållning och/eller utbildning, beroende på aktivitet. Läs igenom hela manualen innan installation och användning.

Read this first / Läs detta först

CAUTION: Breaking the seals (fig 1) to the limit settings may limit and possibly eliminate the warranty.

WARNING: Att bryta förseglingen (fig 1) över dukens gränslägen kan begränsa eller i vissa fall helt eliminera garantin.

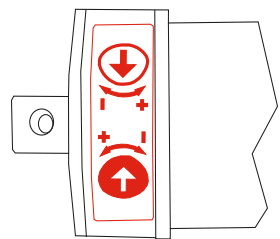

fig 1

Inkoppling Motorer/Motor Wiring

SE För att garantin skall gälla för motoriserade dukar från Draper Europe AB måste de vara inkopplade på ett korrekt sätt. Detta uppnås förslagsvis genom att använda Draper Europe's "Euroscreen Control Box" (Art. 210730).

Används reläboxar/reläer av andra fabrikat är det upp till kunden att funktionskraven nedan uppnås, samt att kunna bevisa korrekt funktion och inkoppling vid en eventuell tvist i ett eventuellt reklamationsärende.

1. **Krav:** Varje fas/"styrkabel" får endast kopplas till ett ensamt relä; d.v.s. flera motorer får inte kopplas in på samma relä/reläer (parallellkoppling).

Orsak: Motorn skickar en bakström vilket vid en parallellkoppling påverkar övriga motorers gränslågen och kan i värsta fall bränna motorns gränsläge eller på annat sätt förstöra motorn.

2. **Krav:** Vid aktivering av fas eller ändring av rotationsändring måste befintlig fas först brytas och fördröjas av en mikropaus.

Orsak: Om ström hamnar/ligger på i båda riktningarna samtidigt påverkas motorns funktion och kan i värsta fall bränna motorns gränsläge eller på annat sätt förstöra motorn.

3. **Krav:** Strömmen får maximalt ligga an på en fas i 5 min och måste sedan brytas.

Orsak: Om ström ligger på i en riktning och endast motorns mikrobrytare/gränslägesbrytare är det som bryter strömmen, påverkas motorns funktion och kan i värsta fall bränna motorns gränsläge eller på annat sätt förstöra motorn.

EN Warranty applies on motorized screens from Draper Europe AB only when they have been properly wired. Preferably, this is achieved by using Draper Europe's "Euroscreen Control Box" (Item #210730/210731).

If relays/relay boxes from another manufacturer is being used, the customer holds all responsibility for making sure that the functional requirements stated below are met. In case of any dispute concerning complaints they also need to prove that the wiring has been made according to these instructions.

1. **Requirement:** Each phase/direction wire can only be wired with one single relay; i.e. no more than ONE motor can be controlled by a single relay (can't be parallel wired).

Cause: The motor transmits a reverse current, which when parallel wired affects the screen limits of other motors. In worst case this could burn the screen limit in the motor, or in other ways destroy it.

2. **Requirement:** When powering a phase or changing the rotation, the existing phase must first be cut off and be delayed by a micro break.

Cause: If the motor is powered in both directions simultaneously the function of the motor is affected and could in worst case burn the screen limit of the motor, or in other ways destroy it.

3. **Requirement:** A phase can only be powered for 5 minutes, and must thereafter be cut off.

Cause: If the motor is powered in more than one direction, and/or if the only thing that cuts off the power is the micro switch/limit switch of the motor, the motor's function is affected and can in worst case burn the screen limit of the motor, or in other ways destroy it.

Assembly / Montering

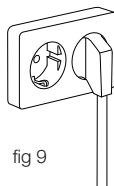
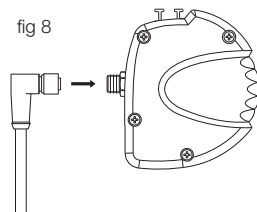
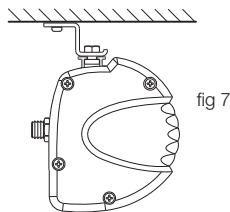
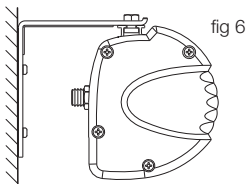
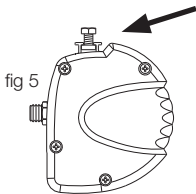
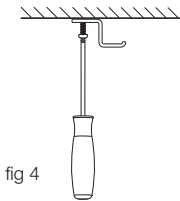
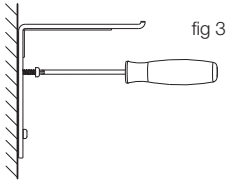
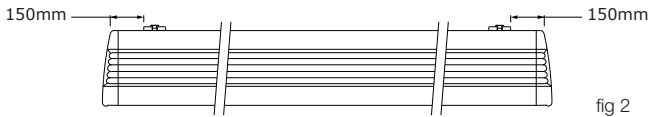

EN: It shall be approximately 150mm from the edges to the brackets (fig 2). If there are three brackets included (only larger screens) the third bracket shall be placed in the middle. Mount the brackets on the wall (fig 3) or in the ceiling (fig 4). Place the nuts together with the screws in the track (fig 5). Mount the screen on the brackets and tighten the screws to 5Nm (fig 6). Connect the cable between the screen (fig 8) and an outlet (fig 9).

SE: Det ska vara cirka 150mm från kanterna till konsolerna (fig 2). Om det ingår tre konsoler (endast större filmdukar) ska den tredje konsol placeras i mitten. Montera konsolerna på väggen (fig 3) eller i taket (fig 4). Placera muttrarna tillsammans med skruvarna i spåret (fig 5). Montera filmduken på konsolerna och spänn åt skruvarna till 5Nm (fig 6). Anslut kablaget mellan duken (fig 8) och ett vägguttag (fig 9).

Adjusting the wiring / Justering av kablaget:

EN: Loosen the locking nut (fig 14).

Turn the connector clockwise to a **maximum of 180 degrees** (fig 15)!

Hold the connector in place while tightening the locking nut (fig 16).

SE: Lossa muttern (fig 14).

Vrid kontakten medsols, **max 180 grader** (fig 15)!

Håll kontakten i önskat läge medan du spänner muttern igen (fig 16).

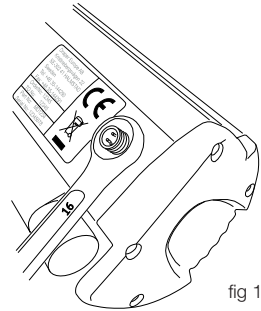

fig 14

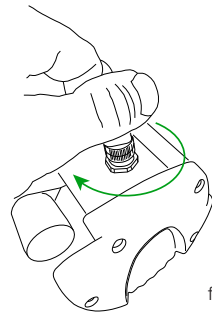

fig 15

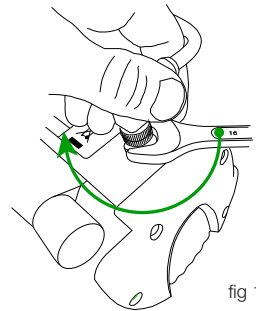

fig 16

Usage / Användning

Electrical specifications / El specifikationer:

	Basic version	Quiet version
Input / Matarspänning:	230V	230V
Power consumption/ Effekt:	121W	115W
Isolation / Isoleringsklass:	IP44	IP44

Cable: Black -	Up/Down
Brown -	Down/Up
Blue -	Neutral
Green/Yellow -	Ground

Kabel: Svart -	Upp/Ner
Brun -	Ner/Upp
Blå -	Neutral
Grön/Gul -	Jord

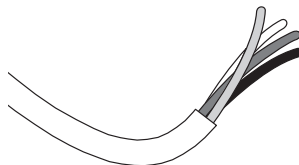

Screen limits / Gränslägen:

EN:

The screen is set at its outer limits when delivered. The upper limit shall never be set higher and the down limit never be set lower.

Warning! Incorrect adjustment of the screen limits may damage the product.

SE: Gränslägena är ställda i dess ytterlägen vid leverans. Övre läget får inte ställas högre och det nedre får inte ställas lägre.

Warning! Felaktig ändring av dukens gränslägen kan skada produkten.

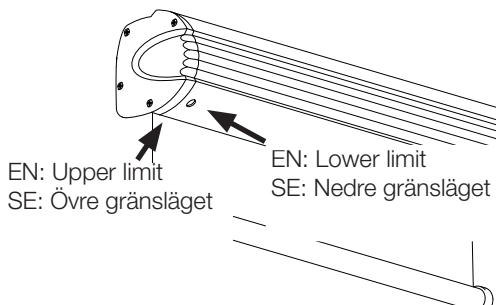

Upper limit / Övre gränsläget:

EN: Upper limit is set by the screw underneath the red field (fig 10). Counterclockwise raises the upper limit and clockwise lowers the upper limit (fig 11).

SE: Övre gränsläget ställs med skruven under det röda fältet (fig 10), där moturs höjer det övre gränsläget och medurs sänker det övre gränsläget (fig 11).

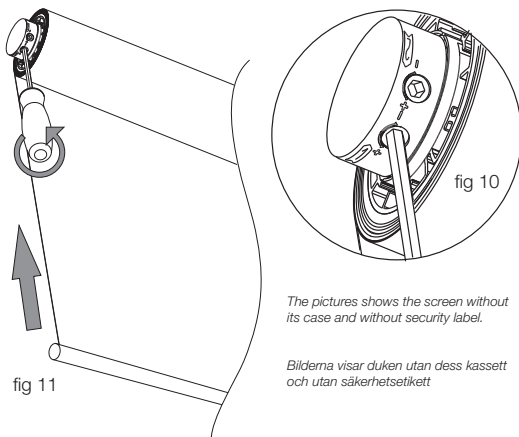

The pictures shows the screen without its case and without security label.

Bilderna visar duken utan dess kassett och utan säkerhetsetikett

Lower limit / Nedre gränsläget:

EN: Lower limit is set by the screw underneath the white field of the security label (fig 12). Counterclockwise increases the screen length and clockwise reduces the screen length (fig 13).

SE: Skruven under säkerhetsetikettens vita fält (fig 12) ställer nedre gräns där moturs sänker ändläget och medurs höjer ändläget (fig 13).

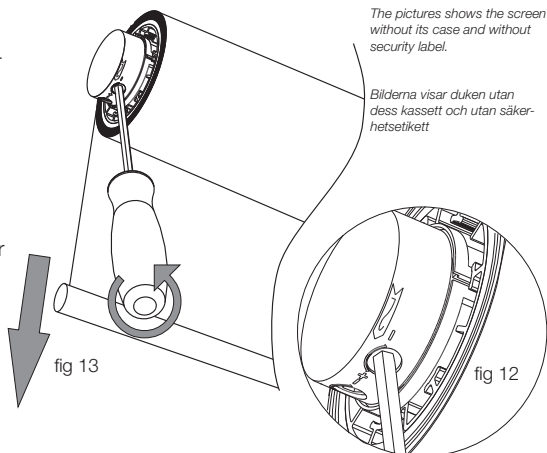

The pictures shows the screen without its case and without security label.

Bilderna visar duken utan dess kassett och utan säkerhetsetikett

NOTE: The actual position of an adjusted limit will only be shown accurately when the screen has been run again. For example: If the lower limit has been adjusted you must run the screen up 10-20 cm and then back down again to see where the limit has been set. Repeat until the desired limit has been achieved.

OBS: Den faktiska positionen av ett justerat läge kommer bara visas efter att duken har körts igen. Till exempel: Om det nedre läget har justerats måste duken köras upp 10-20 cm och sedan ner igen för att se var läget har hamnat. Repetera tills önskat läge uppnåtts.

Conformity of regulations

Draper Europe AB manufactures AV equipment within the brand Euroscreen®. These products are controlled and certified by the below listed regulations.

REACH

Registration, evaluation, authorisation and limitation of chemicals. Regulation (EC) No 1907/2006 of the European Parliament and of the European Council concerning the Registration, Evaluation, Authorisation and Restriction of Chemicals (REACH).

All screen surfaces of Euroscreen® projection screens are approved by the REACH regulation.



ECHA

European Chemicals Agency (ECHA) gathers information on the properties of manufacturers and importers chemical substances, which will allow their safe handling, and to register the information in a central database.



Euroscreen® projection screens are printed with colours containing the following components:

CAS 1333-86-4, CAS 112-36-7, CAS 96-48-0, CAS 143-24-8, CAS 1559-34-8, CAS 2687-91-4, CAS 111-90-0, CAS 34590-94-8 and CAS 126-86-3. These are all approved by ECHA.

RoHS

Restriction of Hazardous Substances Directive (RoHS) directive restricts the use of six hazardous materials in the manufacture of various types of electronic and electrical equipment.

All electrical devices used in Euroscreen® products are RoHS certified.



WEEE

The Waste Electrical and Electronic Equipment Directive (WEEE Directive) is the European Community directive 2002/96/EC on waste electrical and electronic equipment (WEEE) which, together with the RoHS Directive 2002/95/EC, setting collection, recycling and recovery targets for all types of electrical goods.

Applicable Euroscreen® products are labeled with the WEEE symbol.



FR2000

FR2000 is an integrated management system for quality, environment, competence enhancement, health and safety. This system is derived from; ISO 9001, ISO 14001, SS 62 40 70, the Swedish work environment authority regarding systematic environmental progress, and the Swedish rescue services agency regarding systematic fire safety, SRVFS 2004:3.

Draper Europe AB is certified by FR2000 since 2010.



REPA

Producers responsibility for recycling of packaging material is regulated by SFS 2006:1273. The recycling process of packaging material is handled for its members by a central organization called REPA.

Draper Europe AB is a member of REPA.



Declaration of Conformity

Draper Europe confirms that Euroscreen® Electric meets Machinery Directive 2006/95/EG & EMC Directive 2004/108/EC. This is an EN61140 Class I product with internal separation instead of protective conductor (EN61140 7.2.2 Note 2).

Euroscreen® are CE-approved.



Déclaration de conformité

Draper Europe EB fabrique des équipements audiovisuels sous la marque Euroscreen®. Ces produits sont vérifiés et certifiés conformes aux réglementations listées ci-après.

REACH

Registration, evaluation, authorisation and limitation of chemicals. Règlement (EC) No 1907/2006 du Parlement Européen et du Conseil Européen relatif à la déclaration, l'évaluation, l'autorisation et les restrictions s'appliquant aux produits chimiques.

Toutes les toiles des écrans de projection Euroscreen® sont conformes à la directive REACH.



ECHA

L'European Chemicals Agency (ECHA) rassemble les données sur les propriétés des produits chimiques utilisés par les fabricants et importateurs, afin de garantir la sécurité de leur utilisation, et de conserver ces informations dans une base de données centrale.

Les écrans de projection Euroscreen® utilisent des encres contenant les produits suivants :

CAS 1333-86-4, CAS 112-36-7, CAS 96-48-0, CAS 143-24-8, CAS 1559-34-8, CAS 2687-91-4, CAS 111-90-0, CAS 34590-94-8 et CAS 126-86-3 qui sont tous approuvés par l' ECHA.

RoHS

la directive RoHS (Restriction of Hazardous Substances) régit l'usage de six matériaux dangereux dans la fabrication de divers équipements électroniques et électriques.

Tous les équipements et parties d'équipements électriques utilisés dans les produits Euroscreen® sont conformes à la directive RoHS.



WEEE

La directive WEEE (Waste Electrical and Electronic Equipment) est la directive européenne 2002/96/EC sur les déchets électriques et électroniques qui, conjointement avec la directive RoHS 2002/95/EC, définissant les objectifs de collecte, recyclage et récupération de tous types d'équipements électriques.

Les produits Euroscreen® concernés sont étiquetés avec le symbole WEEE.



FR2000

FR2000 est un système de management intégré de la qualité, de l'environnement, de l'amélioration des compétences, de l'hygiène et de la sécurité. Ce système est dérivé des normes ISO9001, ISO 14001, SS 62 40 70, de l'autorité suédoise pour l'environnement de travail en ce qui concerne l'amélioration continue de l'environnement, et des services de secours suédois en ce qui concerne la sécurité incendie SRVFS 2004:3 Draper Europe AB a obtenu la certification FR2000 en 2010.



REPA

La responsabilité des fabricants pour le recyclage des emballages est définie par la norme SFS 2006:1273.

Le traitement de recyclage des emballages est géré pour ses membres par une organisation appelée REPA.

Draper Europe AB est membre de REPA.



Déclaration de Conformité

Draper Europe AB certifie que les matériels Euroscreen® sont conformes à Machinery Directive AFS1994:48, Low Voltage Directive 73-23-EEC & EMC Directive 2004/108/EC.

Les matériels Euroscreen® ont le label CE.



Draper Europe AB • Västervallvägen 6
SE-302 50 Halmstad Sweden

Tel: +46 35-14 42 90 • Fax: +46 35-14 42 91
info@drapereurope.se • www.euroscreens.se